

04

RECESSED FLUORESCENT MODULES

Merga 1
Merga 2
Merga 3
Merga 4
Merga 5
Merga 6
Merga 7
Merga 8
Merga 9





Merga 1

Direct/Indirect Recessed Lay-in Modular

Specular, wedge blade louvre, curved perforated baffle with opal liner and white, gull-wing back reflector, combine to provide subtle, effective general lighting for commercial and retail.

- Suitable for lay-in installation into 15mm/25mm exposed T-grid ceiling
- Wishbone spring fixed louvre for quick fitting and maintenance
- Fitted as standard with High Frequency electronic control gear



2G11

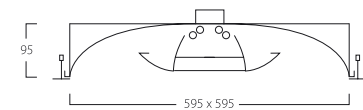

Lamps (Not Inc.)

Lamps (Not Inc.)	Code
1x36W TC-L	ML136
1x40W TC-L	ML140
1x55W TC-L	ML155
2x36W TC-L	ML236
2x40W TC-L	ML240
2x55W TC-L	ML255

Options & Accessories

Code

Emergency Lighting Version
3 hour emergency version (pg 190)

Suffix /SC3

Lighting Controls For Energy Saving

Available fitted with digital dimming ballasts for simple switch dimming or more sophisticated remote control, presence detection and daylight linking. Refer to page 188 for details.

Switch-dimming version
DALI protocol control

Suffix /HFD
Suffix /DALI

Necessary For Plasterboard/Solid Ceilings

625x625x25mm white frame to fit luminaire
Requires 612x612mm cut out.

PK600

'With Lamp' Option

Available to special order

55, 40 & 36W TC-L

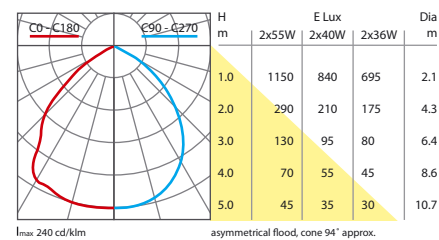

Merga 2

3 or 4 Lamp T5 Recessed Lay-in Modular

Specular Wedge Blade Louvre.

- Suitable for lay-in installation into 15mm/25mm exposed T-grid and plasterboard ceilings
- Wishbone spring fixed louvre for safe, quick fitting and maintenance
- Fitted as standard with High Frequency electronic control gear for T5 lamps
- Perforated infill panels with opal liner



T5

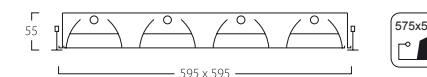

Lamps (Not inc.)

3x14W HE T5	MF314
4x14W HE T5	MF414
3x24W HO T5	MF324
4x24W HO T5	MF424

Options & Accessories

Code

Emergency Lighting Version
3 hour emergency version (pg 190)

Suffix /SC3

Lighting Controls For Energy Saving

Available fitted with digital dimming ballasts for simple switch dimming or more sophisticated remote control, presence detection and daylight linking. Refer to page 188 for details.

Switch-dimming version
DALI protocol control

Suffix /HFD
Suffix /DALI

Optional For Plasterboard/Solid Ceilings

625x625x25mm white frame to fit luminaire
Requires 612x612mm cut out.

PK600

'With Lamp' Option

Available to special order

3 Lamp 24W & 14W T5

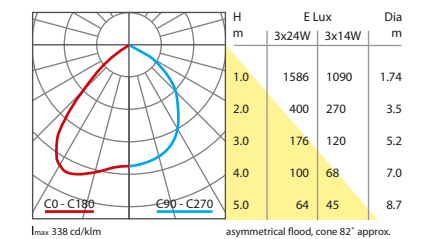

4 Lamp 24W & 14W T5

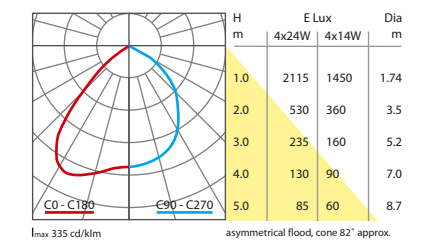



Merga 3

4 Lamp T5 Recessed Lay-in Modular

Specular Wedge Blade Louvre and side panels for side light.

- Suitable for lay-in installation into 15mm/25mm exposed T-grid and plasterboard ceilings
- Wishbone spring fixed louvre for safe quick fitting and maintenance
- Fitted as standard with High Frequency electronic control gear for T5 lamps
- Perforated, lit infill panels with opal liner
- Acrylic panels provide diffused side lighting to adjacent ceiling

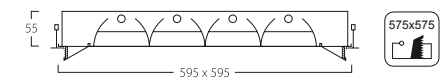
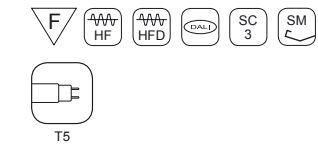

Lamps (Not Inc.)	Code
4x14W HE T5	MA414
4x24W HO T5	MA424

Options & Accessories	Code
Emergency Lighting Version 3 hour emergency version (pg 190)	Suffix /SC3

Lighting Controls For Energy Saving
Available fitted with digital dimming ballasts for simple switch dimming or more sophisticated remote control, presence detection and daylight linking. Refer to page 188 for details.

Switch-dimming version	Suffix /HFD
DALI protocol control	Suffix /DALI

Optional For Plasterboard/Solid Ceilings
625x625x25mm white frame to fit luminaire
Requires 612x612mm cut out. PK600

'With Lamp' Option Available to special order

4 Lamp T5 Versions

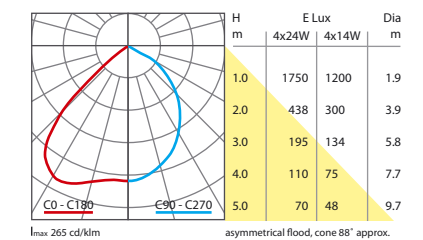



Merga 4

3 & 4 Lamp T5 Recessed Lay-in Modular

Specular wedge blade louvre and acrylic side refractors.

- Fitted as standard with High Frequency electronic control gear for T5 lamps
- Sidekick refractor allows light spill to the adjacent ceiling
- For installation within 15mm/25mm exposed T and plasterboard ceilings

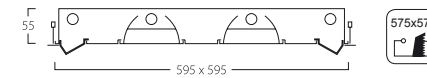
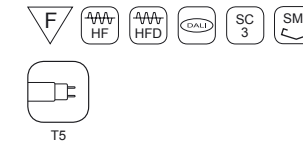

Lamp	Code
4x14W HE T5	MR414
4x24W HO T5	MR424
3x14W HE T5	MR314
3x24W HO T5	MR324

Options & Accessories	Code
Emergency Lighting Version 3 hour emergency version (pg 190)	Suffix /SC3

Lighting Controls For Energy Saving
Available fitted with digital dimming ballasts for simple switch dimming or more sophisticated remote control, presence detection and daylight linking. Refer to page 188 for details.

Switch-dimming version	Suffix /HFD
DALI protocol control	Suffix /DALI

Optional for Plasterboard/Solid Ceilings
625x625x25mm white frame to fit luminaire
Requires 612x612mm cut out.

'With Lamp' Option Available to special order

3 and 4 lamp T5

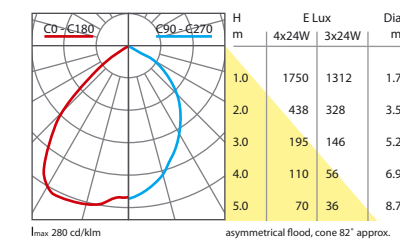



Merga 5

Recessed Wall Washer

Sheet steel housing with specular aluminium asymmetric reflector optics to provide efficient and effective vertical luminance uniformity with excellent glare control. Suitable for mounting in 15mm/25mm exposed T or plasterboard ceilings.

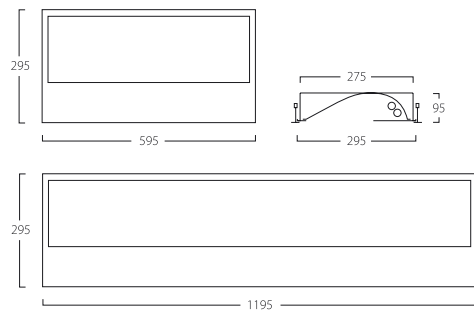
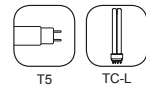

Lamp	Nom Size	Code
1x24W HO T5	300x600	MU124
1x54W HO T5	300x1200	MU154
1x40W TC-L	300x600	MU140
2x40W TC-L	300x1200	MU240
1x55W TC-L	300x600	MU155
2x55W TC-L	300x1200	MU255

Options & Accessories

Emergency Lighting Version
3 hour emergency version (pg 190) Suffix /EM3

Lighting Controls For Energy Saving (pg 188)
Switch-dimming version Suffix /HFD
DALI protocol control Suffix /DALI

'With Lamp' Option Available to special order

Illuminance on wall from luminaire mounted 1.2m from wall
1x55W TC-L

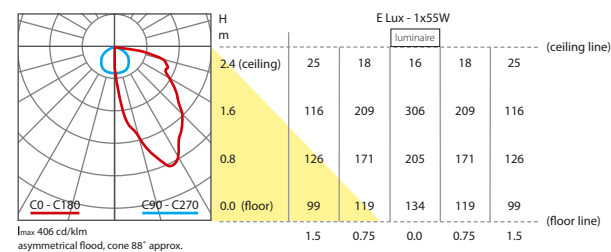

Merga 6

Recessed Direct/Indirect Module with Drop Basket

Recessed 600x600 modular fluorescent. High specification architectural luminaire that is designed for compatibility with today's commercial interiors. Utilises a micro drop basket reflector that harnesses a combination of direct and indirect light to create a soft ambience.

- Suitable for installation in 15mm/25mm exposed T-grid ceiling
- Perforated dropped basket with opal inner lining for diffused illumination
- High Frequency electronic control gear as standard

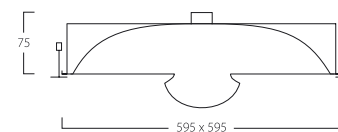

Lamp	Code
2x36W TC-L	MB236
2x40W TC-L	MB240
2x55W TC-L	MB255

Options & Accessories

Emergency Lighting Version
3 hour emergency version (pg 190) Suffix /SC3

Lighting Controls For Energy Saving
Available fitted with digital dimming ballasts for simple switch dimming or more sophisticated remote control, presence detection and daylight linking. Refer to page 188 for details.

Switch-dimming version Suffix /HFD
DALI protocol control Suffix /DALI

Necessary For Plasterboard/Solid Ceilings
625x625x25mm white frame to fit luminaire PK600
Requires 612x612mm cut out.

'With Lamp' Option Available to special order

2x55W, 2x40W & 2x36W TC-L

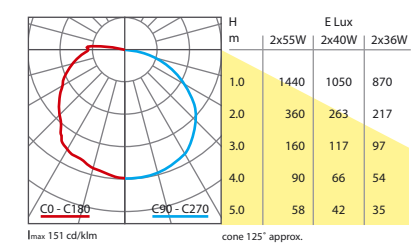



Merga 7

Recessed Direct/Indirect TC-L Module

High specification architectural luminaire designed for compatibility with today's commercial and retail interiors. Utilising a micro lamp basket and full width reflector to create a flush ceiling line and subtle lighting effect.

- Suitable for installation in 15mm/25mm exposed T-grid ceiling
- Perforated, curved reflector with opal inner lining for diffused illumination
- High Frequency electronic control gear a standard



2G11

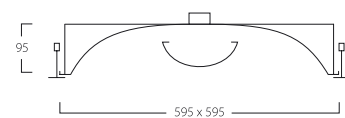

Lamps (Not Inc.)	Code
2x40W TC-L	MC240
2x55W TC-L	MC255

Options & Accessories	Code
-----------------------	------

Emergency Lighting Version
3 hour emergency version (pg 190) Suffix /SC3

Lighting Controls For Energy Saving
Available fitted with digital dimming ballasts for simple switch dimming or more sophisticated remote control, presence detection and daylight linking. Refer to page 188 for details.

Switch-dimming version Suffix /HFD
DALI protocol control Suffix /DALI

Necessary For Plasterboard/Solid Ceilings
625x625x25mm white frame to fit luminaire PK600
Requires 612x612mm cut out.

'With Lamp' Option Available to special order

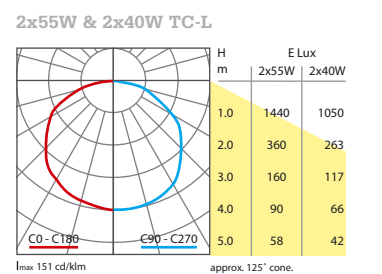



Merga 8

Recessed T8 Wedge Blade Louvre (CAT 2) Module

High specification architectural luminaire that is designed for compatibility with today's commercial interiors with specular wedge blade CAT 2 louvre.

- Suitable for installation in 15mm/25mm exposed T and most concealed grid ceilings
- Specular wedge blade louvre (wishbone spring)
- 4x sidearm support brackets
- Available wattage: 4x18W and 4x36W T8



Lamps (Not Inc.)	Nom Size	Switchstart	High Frequency
4x18W T8	600x600	MD418	MD418HF
4x36W T8	600x1200	MD436	MD436HF

Options & Accessories Code

Emergency Lighting Version
3 hour emergency version (pg 190) Suffix /EM3

Lighting Controls For Energy Saving
Available fitted with digital dimming ballasts for simple switch dimming or more sophisticated remote control, presence detection and daylight linking. Refer to page 180 for details.

Switch-dimming version Suffix /HFD
DALI protocol control Suffix /DALI

Optional for Plasterboard/Solid Ceilings
625x625x25mm white frame to fit luminaire PK600
Requires 612x612mm cut out.

'With Lamp' Options Available Available to special order

4 Lamp T8

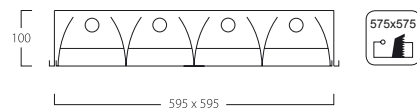
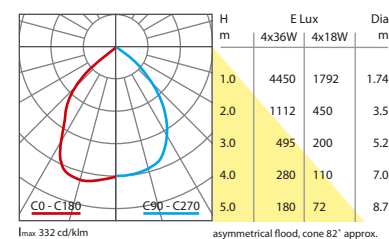

Merga 9

IP54 Clean Room Module

Recessed IP54 T8 modules developed for clean room areas.

- IP54 protection to lit space
- Suitable for installation in 15mm/25mm exposed T-grid and plasterboard ceilings
- Prismatic polycarbonate TP (a) rated panel as standard
- Available wattage: 4x18W T8 and 4x36W T8



Lamps (Not Inc.)	Nom Size	Switchstart	High Frequency
4x18W T8	600x600	PS418	PS418HF
4x36W T8	600x1200	PS436	PS436HF

Options & Accessories Code

Emergency Lighting Version
3 hour emergency version (pg 190) Suffix /EM3

Lighting Controls For Energy Saving
Available fitted with digital dimming ballasts for simple switch dimming or more sophisticated remote control, presence detection and daylight linking. Refer to page 188 for details.

Switch-dimming version Suffix /HFD
DALI protocol control Suffix /DALI

'With Lamp' Options Available to special order

4 Lamp T8

