

06

LINEAR SURFACE



Vela 1
Vela 2
Vela 3

Vela 1

Pendant, Surface and Track Mounted T5 Luminaire



Vela 1, with its clean minimalist design - only 35mm visible depth - and T5 technology will only serve to enhance a contemporary space.

Vela 1 is extremely versatile. Surface pendant and track mounting options as well as optional uplighting facilities to aid LG3 compliance, make Vela 1 viable in a wide range of applications from retail to the modern office.



Vela 1

Pendant, Surface and Track Mounted T5 Luminaire

High specification surface mounted luminaire in powder coated mild steel with specular wedge blade louvre. For prestigious retail and commercial applications.

- Optics designed for T5 lamps (not included)
- Ultra slim profile
- Continuous mounting facilities
- Plug and socket, connection to and between luminaires
- White to RAL 9010 or Aluminium to RAL 9006

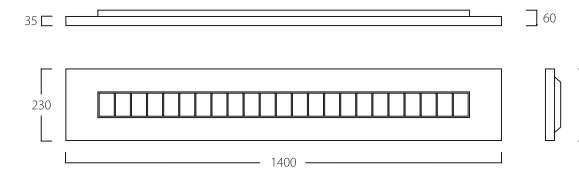
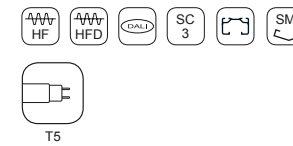

Pendant Version

Without backplate to allow upward light (Not Inc. Pendant Kit)

Lamp (Not Inc.)	White	Aluminium
1x28W HE T5	TES128	TES130
2x28W HE T5	TES228	TES230
1x54W HO T5	TES154	TES156
2x54W HO T5	TES254	TES256

Surface Mounted Version

Lamp (Not Inc.)	White	Aluminium
1x28W HE T5	TEC128	TEC130
2x28W HE T5	TEC228	TEC230
1x54W HO T5	TEC154	TEC156
2x54W HO T5	TEC254	TEC256

Track Mounted Version

With flying lead adaptor for Single Circuit Sirius 2 track

Lamp (Not Inc.)	White	Aluminium
1x28W HE T5	TET128	TET130
2x28W HE T5	TET228	TET230
1x54W HO T5	TET154	TET156
2x54W HO T5	TET254	TET256

Version for Three circuit Sirius 3 track Suffix /ETA

Options & Accessories

	Code
Pendant Suspension Kit (with surface plate) 1.5m steel wires and supply flex	Suffix /PK
Clear Acrylic Back Panel (TES versions only) To allow upward light Tinted versions available on request.	Suffix /TBC
White Steel Back panel (TES versions only) to prevent upward light	Suffix /BP
Emergency Lighting Version 3 hour maintained emergency version in remote enclosure The emergency module and batteries are fully integral.	Suffix /SC3
Lighting Controls For Energy Saving (pg 188) Switch-dimming version DALI protocol control	Suffix /HFD Suffix /DALI

'With Lamp' Option Available to special order



2x54W, 1x54W, 2x28W, 1x28W T5

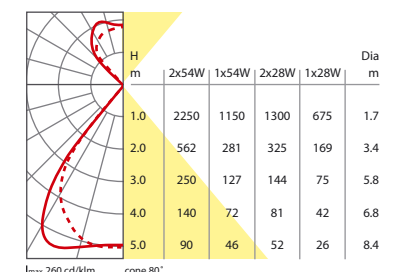

Vela 2

Slim Profile, Surface or Pendant Mounted Luminaires

- Constructed in powder coated sheet steel with injection moulded end caps
- Anti-iridescence, specular aluminium, low glare, wedge blade louvre

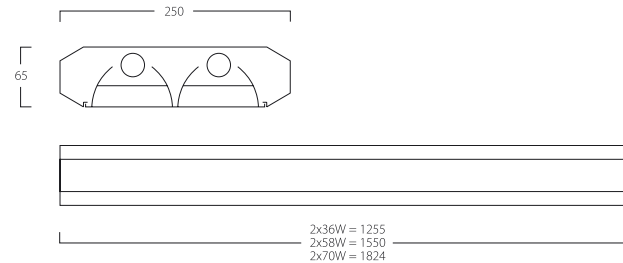

Lamps (Not Inc.)	Control Gear	Code
2x36W T8	High Frequency	DLC236HF
2x58W T8	High Frequency	DLC258HF
2x70W T8	High Frequency	DLC270HF

Lamps (Not Inc.)	Control Gear	Code
2x36W T8	Switchstart	DLC236
2x58W T8	Switchstart	DLC258
2x70W T8	Switchstart	DLC270

Options & Accessories

Emergency Lighting Version
Maintained self contained 3 hour emergency version
The emergency module and batteries are fully integral. Suffix / SC3

Pendant Unit
Adjustable in length and complete with 3 core cable Suffix / PK

Lighting Controls For Energy Saving (pg 188)
Switch-dimming version Suffix /HFD
DALI protocol control Suffix /DALI

'With Lamp' Version Available to special order

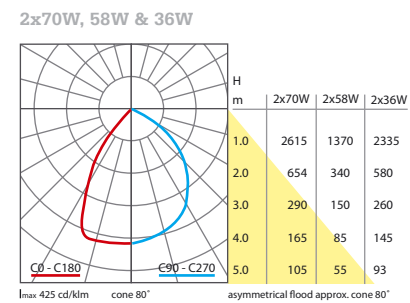

Vela 3

Surface Mounted T8 Luminaire with Extruded Prismatic Diffuser

Suitable for classrooms, canteens, restaurants, staircases, etc.

- PMMA UV stabilised prismatic diffuser
- Available wattage: 1x36W, 2x36W, 1x58W, 2x58W, 1x70W, 2x70W

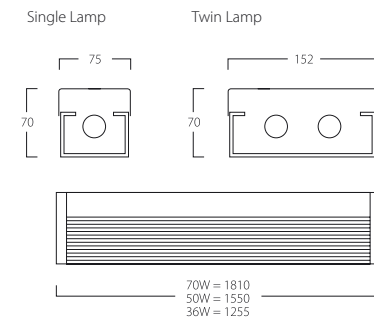
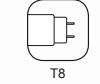

Single Lamp (Not Inc.)	Switchstart	High Frequency
1x36W	DL136	DL136HF
1x58W	DL158	DL158HF
1x70W	DL170	DL170HF

Twin Lamp (Not Inc.)	Switchstart	High Frequency
2x36W	DL236	DL236
2x58W	DL258	DL258
2x70W	DL270	DL270

Options & Accessories

Emergency Lighting Version
Maintained self contained 3 hour emergency version
The emergency module and batteries are fully integral. Suffix /SC3

'With Lamp' Version Available to special order

1x70W, 58W & 36W

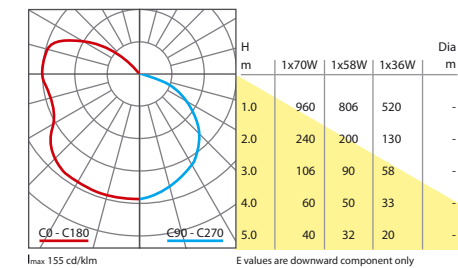

2x70W, 58W & 36W

